

Data Sheet



Article number: 588N2B116CB0411

Description: Solenoid valve type N2B116.CB0.411 2/2 NC
24 VAC 50HZ orifice 1,6 housing in Brass Inlet port G1/8"

Measures

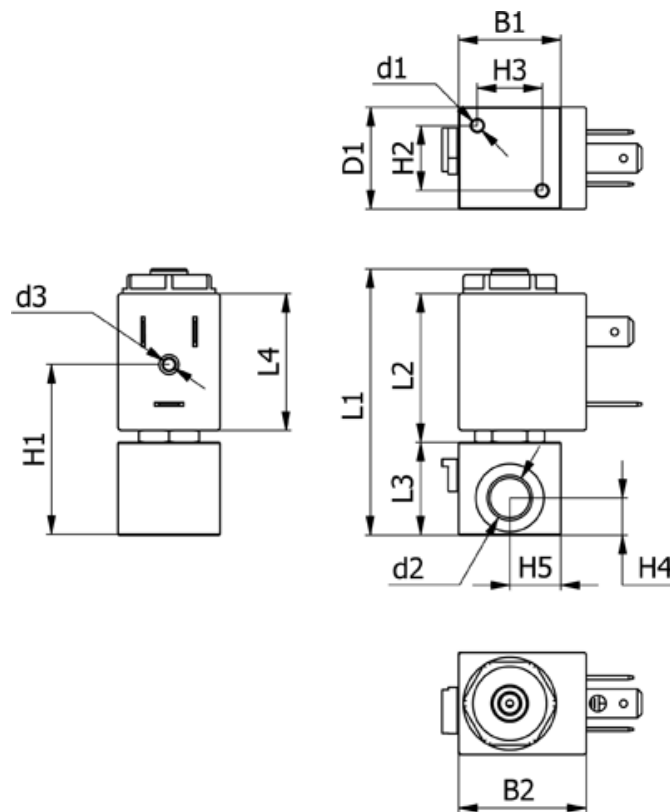

B1 = 20	H2 = 14	Orifice = 1.6
B2 = 26.5	H3 = 14	Valve function = 2/2 NC
d1 = M3x6	H4 = 10	Voltage = 24 VAC 50HZ
D1 = 30	H5 = 10	
d2 = G1/2"	L1 = 56.2	
d3 = M3x4	L2 = 32.1	
Flow = 1.1	L3 = 20	
H1 = 36.6	L4 = 29.5	